



**AON120D
Fiber Mini
Node**

**Quick Reference
Guide**

Revision J

ACT AON120D Fiber Mini Node

Quick Reference Guide

ACT Document Number: ACT AON120D QRG

Quick Reference Guide Revision J

Copyright © 2026 Ascent Communication Technology Limited.

All rights reserved. Reproduction in any manner whatsoever without the express written permission of Ascent Communication Technology is strictly forbidden.

This document is produced to assist professional and properly trained personnel with installation and maintenance issues for the product. The capabilities, system requirements and/or compatibility with third-party products described herein are subject to change without notice.

For more information, contact ACT: support@ascentcomtec.com



Revision History

Revision	Date	Reason for Change
A	04/26/2019	Initial release
B	05/15/2019	Minor updates
C	02/05/2020	Updating specifications table
D	06/24/2020	Updated section 4
E	30/09/2021	Update output level to 76 dBμV ±1 dBμV with AGC
F	10/04/2021	Minor updates
G	01/03/2022	Updated section 1.5
H	01/04/2022	Updated section 1.3
I	09/19/2025	Updated section 1.3

Table of Contents

1 Introduction	5
1.1 Overview	5
1.2 Features.....	6
1.3 Specifications	7
1.4 System Connection	8
1.5 Models and Options.....	8
1.6 Block Diagram	9
2 Configuration and Installation.....	9
2.1 Equipment Inventory	9
2.2 Power and Cooling Requirements.....	9
2.3 Setting up the AON120D.....	9
3 Distortion Performance.....	11
4 Three-Wavelengths WDM Module	12
4.1 Features.....	12
4.2 Applications.....	12
4.3 WDM Specifications	12
4.4 PD Pin Assignment	13
4.5 Mechanical Dimensions	13
5 Troubleshooting	14

Precautions



Exposure to class 1M laser radiation is possible. Access should be restricted to trained personnel only. Do not view exposed fiber or connector ends when handling optical equipment.



- Ensure adequate cooling and ventilation as specified.
- The installation and operation manual should be read and understood before units are put into use.
- **Always replace protective caps on optical connectors when not in use.**
- The typical connectors fitted are SC/APC 8°. **Note:** 8° angle polished connectors must be used.

Cleaning

Use only a damp cloth for cleaning the front panel. Use a soft dry cloth to clean the top of the unit.

Do not use spray cleaner of any kind.

Overloading

Overloading wall outlets and extension cords can result in a risk of fire or electric shock.

Use approved electrical cords.

Damage requiring service

Unplug unit and refer servicing only to Ascent Communication Technology qualified service personnel.

Servicing

Do not attempt to service this unit yourself. Refer all servicing only to Ascent Communication Technology qualified service personnel.

General Reminders and Warnings

Review these reminders and warnings before you inspect and clean your fiber-optic connections.

Reminders



- **Always turn off any laser sources before you inspect fiber connectors, optical components, or bulkheads.**
- Always make sure that the cable is disconnected at both ends and that the card or pluggable receiver is removed from the chassis.
- **Always wear the appropriate safety glasses when required in your area. Be sure that any laser safety glasses meet federal and state regulations and are matched to the lasers used within your environment.**
- Always inspect the connectors or adapters before you clean.
- Always inspect and clean the connectors before you make a connection.
- Always use the connector housing to plug or unplug a fiber.
- **Always keep a protective cap on unplugged fiber connectors.**

- Always store unused protective caps in a resealable container in order to prevent the possibility of the transfer of dust to the fiber. Locate the containers near the connectors for easy access.
- Always discard used tissues and swabs properly.

Warnings



- Never use alcohol or wet cleaning without a way to ensure that it does not leave residue on the endface. It can cause damage to the equipment.
- **Never look into a fiber while the system lasers are on.**
- Never clean bulkheads or receptacle devices without a way to inspect them.
- Never touch products without being properly grounded.
- **Never use unfiltered handheld magnifiers or focusing optics to inspect fiber connectors.**
- **Never connect a fiber to a fiberscope while the system lasers are on.**
- Never touch the end face of the fiber connectors.
- Never twist or pull forcefully on the fiber cable.
- Never reuse any tissue, swab, or cleaning cassette reel.
- Never touch the clean area of a tissue, swab, or cleaning fabric.
- Never touch any portion of a tissue or swab where alcohol was applied.
- Never touch the dispensing tip of an alcohol bottle.
- Never use alcohol around an open flame or spark; alcohol is very flammable.

1 Introduction

1.1 Overview

AON120D Series FTTH mini node supports Video Overlay application over FTTH optical fiber access network. It operates on 42 MHz to 1006 MHz RF bandwidth, with high output power up to 75 dB μ V (AGC). AON120D has low power consumption and optional built-in WDM to support PON signal pass-through. It is part of ACT's Deep Fiber and FTTH solution, which helps operators provide superior video services in a FTTH PON network architecture.

The AON120D Mini Node adopts high sensitivity optical receiver and specially designed low noise matching circuit. The mini node provides high output and is installed at the subscriber premises, suitable for advanced FTTx, high density MDU, SMB, or hospitality market applications. The AON120D mini node is designed with built in WDM optical passive, which will pass the GPON 1310/1490nm and XGS PON 1270/1577nm data wavelength to the ONU/ONT CPE device.

With the compact housing, modular design, AON120D mini node provides the flexible configuration for MSOs to deliver advanced video services to their customer. This fiber deep product series improve overall network performance, and offer sufficient bandwidth for new application demand.

1.2 Features

- 1002 MHz RF Spectrum for superior video services
- Small form factor and low power consumption
- 1310/1490 nm PON wavelength compatible
- 1270/1577 XGSPON wavelength compatible
- Wide optical receiving range: -15 dBm to +2 dBm
- Optical AGC to keep constant output level in different optical input power
- RF output level: 76 dB μ V @ -12 dBm optical input power
- LED indicator for optical power and power supply
- Powered directly using the power adaptor
- Compact enclosure fits easily in CPE, ONU housing or network termination boxes
- Special heat dissipation design

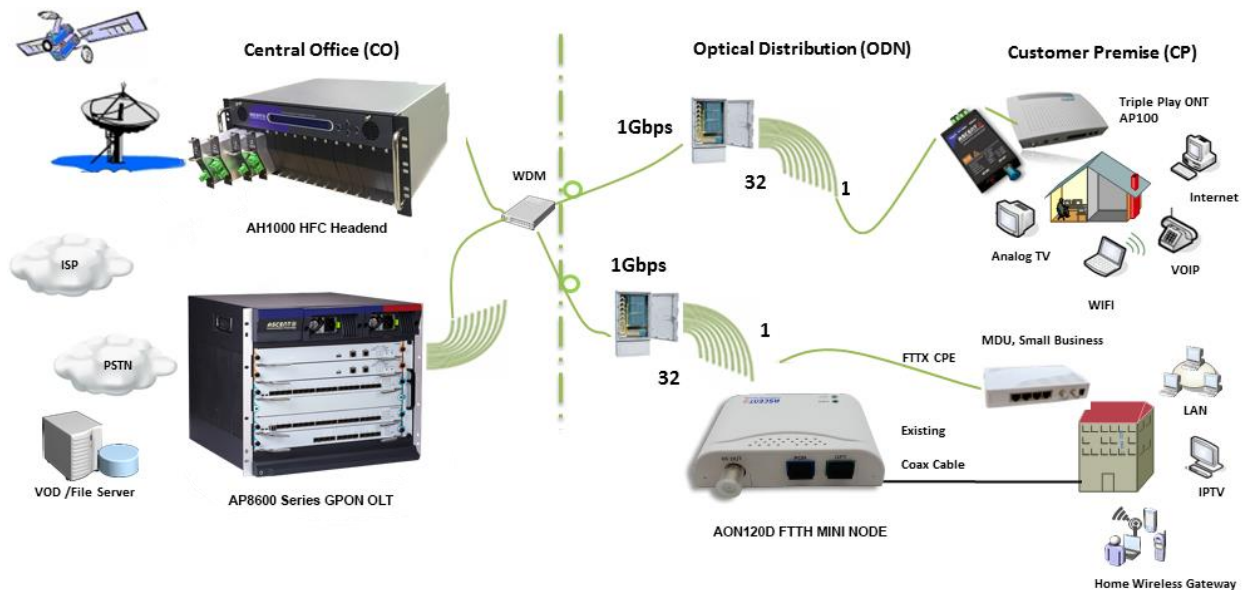

1.3 Specifications

AON120D FTTH Deep Fibre Mini Node

Downstream Characteristics (Receiver)

Parameter	Value
CATV Wavelength Range	1260nm to 1620nm (without WDM filter) 1540nm to 1560nm (with WDM filter)
Optical Input Power	-15dBm to +2dBm (AGC: -12 dBm to -2 dBm) >-15dBm (1550 nm LED Green) <-15dBm (1550 nm LED Red)
Optical Return Loss	45dB (typ.)
Responsivity	>0.9A/W @ 1550nm
RF Bandwidth	47 MHz to 1002 MHz, 1218 MHz
Output Level	76dB[iV @ -12dBm to -2dBm (AGC)
RF Flatness	±1.0dB (47 MHz to 1002 MHz)
RF Return Loss	≥16dB
RF Input Impedance	75Ω
RF Connector	F-Female

Link Index

CNR	43.0dB (-9dBm input, 60 PAL Channels)
CTB	-55dBc
CSO	-55dBc
MER	38dB (-9dBm input, 60 PAL Channels)

General Index

Optical Connector	SC/APC, SC/APC, LC/APC
Operating Temperature	-10°C to 50°C
Storage Temperature	-40°C to 85°C
Power Supply	+12 V DC
Operating Relative Humidity	5% to 95%
Power Consumption	<2W
Dimensions(W x D x H)	73mm x 60mm x 23mm
Weight	0.2kg
Ship Weight	18kg (Packed in carton boxes of fifty units)

1.4 System Connection

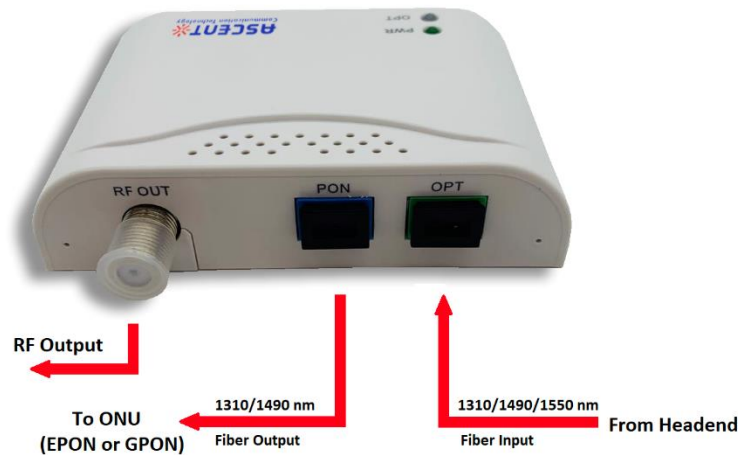

AON120D Ports

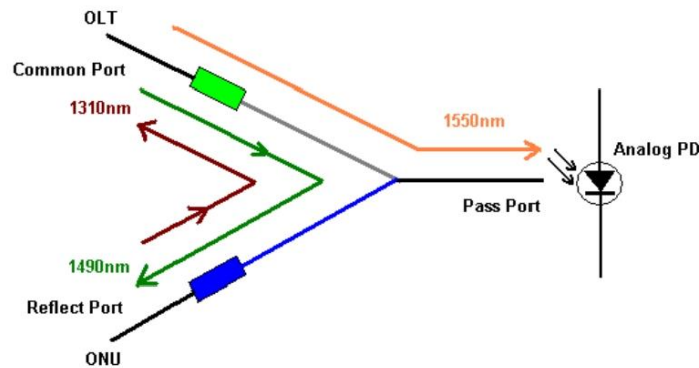

AON120D PON Signal Bypassing Diagram

1.5 Models and Options

AON120D Series FTTH Mini Node Ordering Information																					
AON120D-	X-	X-	XX-	XX-	XX-	XX-	X														
	<table border="1"> <tr><th>RF Bandwidth</th></tr> <tr><td>A 1002 MHz</td></tr> <tr><td>B 1218 MHz</td></tr> </table>	RF Bandwidth	A 1002 MHz	B 1218 MHz		<table border="1"> <tr><th>Output Power</th></tr> <tr><td>AG 76dBuV @-12~+2dBm</td></tr> </table>	Output Power	AG 76dBuV @-12~+2dBm		<table border="1"> <tr><th>OPT. Input Connector</th></tr> <tr><td>AS SC/APC</td></tr> <tr><td>LA LC/APC</td></tr> <tr><td>US SC/UPC</td></tr> </table>	OPT. Input Connector	AS SC/APC	LA LC/APC	US SC/UPC		<table border="1"> <tr><th>Power Adaptor</th></tr> <tr><td>01 Australia</td></tr> <tr><td>02 China</td></tr> <tr><td>03 Continental Europe</td></tr> <tr><td>04 North America</td></tr> </table>	Power Adaptor	01 Australia	02 China	03 Continental Europe	04 North America
RF Bandwidth																					
A 1002 MHz																					
B 1218 MHz																					
Output Power																					
AG 76dBuV @-12~+2dBm																					
OPT. Input Connector																					
AS SC/APC																					
LA LC/APC																					
US SC/UPC																					
Power Adaptor																					
01 Australia																					
02 China																					
03 Continental Europe																					
04 North America																					
			<table border="1"> <tr><th>WDM</th></tr> <tr><td>0 No WDM Filter (1550/1310/1490 all pass)</td></tr> <tr><td>F WDM Filter (1550 pass) w/o PON Port</td></tr> <tr><td>X XGS WDM (1550 pass) w PON Port (1310/1490, 1270/1577)</td></tr> </table>	WDM	0 No WDM Filter (1550/1310/1490 all pass)	F WDM Filter (1550 pass) w/o PON Port	X XGS WDM (1550 pass) w PON Port (1310/1490, 1270/1577)	<table border="1"> <tr><th>PON Connector</th></tr> <tr><td>No PON Conn</td></tr> <tr><td>AS SC/APC</td></tr> <tr><td>LA LC/APC</td></tr> <tr><td>US SC/UPC</td></tr> </table>	PON Connector	No PON Conn	AS SC/APC	LA LC/APC	US SC/UPC		<table border="1"> <tr><th>Customization</th></tr> <tr><td>0 Default Standard Model</td></tr> </table>	Customization	0 Default Standard Model				
WDM																					
0 No WDM Filter (1550/1310/1490 all pass)																					
F WDM Filter (1550 pass) w/o PON Port																					
X XGS WDM (1550 pass) w PON Port (1310/1490, 1270/1577)																					
PON Connector																					
No PON Conn																					
AS SC/APC																					
LA LC/APC																					
US SC/UPC																					
Customization																					
0 Default Standard Model																					

1.6 Block Diagram

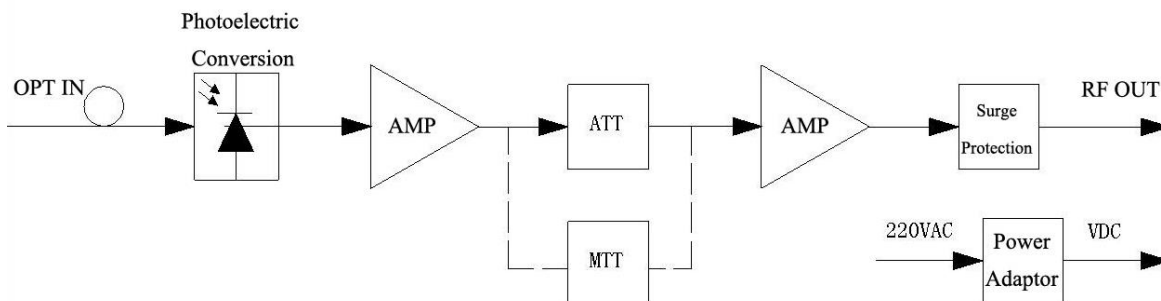

2 Configuration and Installation

This chapter introduces AON120D setup and installation. Before installing the equipment, please read this chapter thoroughly.

2.1 Equipment Inventory

On receiving your new AON120D unit, you should carefully unpack and examine the contents for loss or damage that may have occurred during shipping. Refer to warranty registration if loss or damage has occurred. The AON120D should consist of the following:

Qty	Description
1	AON120D Mini Node
1	Optional Quick Reference Guide (Ref: Online version)
1	Universal 12 VDC power supply plug-pack

2.2 Power and Cooling Requirements

The AON120D requires an external supply of 11 V DC to 16 V DC. The maximum power consumption of the unit is 3 W. A universal 12 V DC power supply plug-pack is supplied with the unit, and is suitable for 95 V AC to 265 V AC 50/60 Hz with selectable mains pins for Australia, Continental Europe, United Kingdom and United States.

The AON120D is specified for operation between -20 °C to +50 °C. Ensure that the unit is mounted in such a way as to permit airflow around the front and sides at all times.

2.3 Setting up the AON120D



Exposure to class 1M laser radiation is possible. Access should be restricted to trained personnel only.

Warning

1. Ensure that the unit is complete with all expected equipment
2. If you are mounting the unit in a wiring closet or meter box, do this **before** connecting the optical and coaxial cables. Keep in mind appropriate clearances for these cables, air flow etc.
3. Connect the RF OUT port to the RF signal output.
4. Optical Input Port: Connect to forward fiber with SC/APC connector
5. PON Pass Port: Connect to PON signal fiber with SC/APC connector.
6. Connect CATV+PON and PON Pass to the CATV Coaxial network and the ONU.
7. Connect power to the unit via the power port
8. Check that the Status LEDs is on. When optical receiving power is higher than -12 dBm, the LED indicator will be green. When optical receiving power is lower than -12 dBm, the LED indicator will be red.
9. Ensure that the Status Alarm LED is green. Orange or Red indicates that the received optical level is too low or too high, and is at risk of damaging the unit.
10. User can adjust the RF Output power by the adjustable attenuator: Output level adjustment range of 0 to 20 dB.

3 Distortion Performance

PIN (DBM)	VO (DBμV)	MER	BER		PIN (DBM)	VO (DBμV)	MER	BER	
			POST	PER				POST	PER
+2.0	70.9	38.8	<1.0E-9	<1.0E-9	-8.0	81.6	38.7	<1.0E-9	<1.0E-9
+1.0	82.1	38.8	<1.0E-9	<1.0E-9	-9.0	80.0	38.6	<1.0E-9	<1.0E-9
0.0	80.8	38.8	<1.0E-9	<1.0E-9	-10.0	78.3	38.5	<1.0E-9	<1.0E-9
-1.0	81.7	38.8	<1.0E-9	<1.0E-9	-11.0	76.0	38.4	<1.0E-9	<1.0E-9
-2.0	81.7	38.8	<1.0E-9	<1.0E-9	-12.0	74.3	38.2	<1.0E-9	<1.0E-9
-3.0	81.9	38.8	<1.0E-9	<1.0E-9	-13.0	72.5	37.8	<1.0E-9	<1.0E-9
-4.0	81.8	38.8	<1.0E-9	<1.0E-9	-14.0	70.4	37.5	<1.0E-9	<1.0E-9
-5.0	81.7	38.8	<1.0E-9	<1.0E-9	-15.0	68.6	36.9	<1.0E-9	<1.0E-9
-6.0	81.7	38.8	<1.0E-9	<1.0E-9	-16.0	66.7	36.2	<1.0E-9	<1.0E-9
-7.0	81.9	38.7	<1.0E-9	<1.0E-9	-17.0	64.9	35.2	<1.0E-9	<1.0E-9

- Notes: 1. Pin = +2.0 dBm to -20 dBm
 2. Test Signal: KAB3000 MER: 38.8 (dB), BER <1.0E-9
 3. Channel Load: 4CH QAM64
 4. Test Equipment: JDSU SDA4040D

CNR, MER Degradation Table

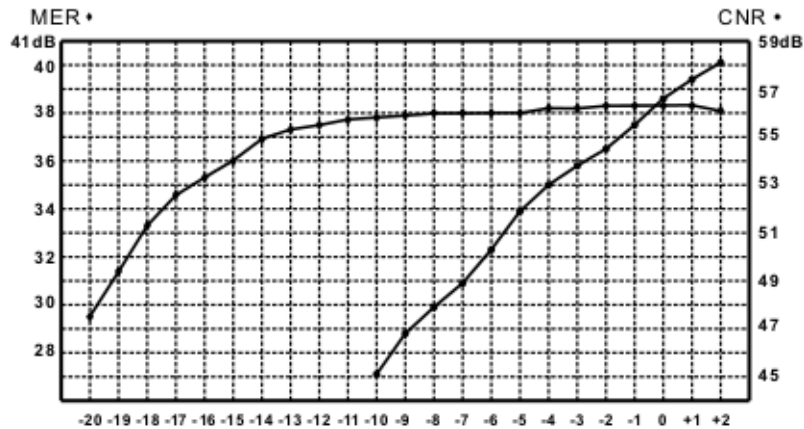

- Notes: 1. CNR test conditions: 59CH PAL-D, OMI = 3.8%
 2. Digital TV test signal: The original signal MER = 38.8 dB. BER < 1.0E-9 TV
 Input Level: 87 dbμV

4 Three-Wavelengths WDM Module

4.1 Features

- Low insertion loss
- Low return loss
- High channel separation
- High stability and reliability
- No plastic optical path
- Connector: SC/APC, LC/APC
- Fiber type: SM, 9/125, 900 μm, G657A2
- RoHS compliant

4.2 Applications

- Light circuit terminal, optical network unit
- FTTH
- Optical transceiver
- Cable TV systems
- WDM systems

4.3 WDM Specifications

Absolute Maximum Ratings (Tc = 25 °C)

Parameter	Symbol	Value
Saturation power	Ps	2.0 mW
Forward current	If	2.0 mA
Reverse voltage	Vr	15 V
Operating temperature	Top	-40 °C to +85 °C
Storage temperature	Tst	-40 °C to +85 °C
Lead Soldering (Temperature)/(Time)	-	260/10 °c/sec

Optical and Electrical Characteristics (Tc = 25 °C)

Parameter	Symbol	Min.	Typ.	Max.	Unit	Remarks
Wavelength Range	λ_{op}	1260		1660	nm	
Pass Channel Wavelength Range	λ_1	1555		1560	nm	
Reflect Channel Wavelength	λ_2	1260		1330	nm	

	λ_3	1470	1510	nm	
	λ_4	1575	1580	nm	
	λ_5	1596	1603	nm	
	λ_6	1603	1625	nm	
	λ_7	1625	1660	nm	
Responsivity	Res	0.9		A/W	$\lambda = 1550 \text{ nm}, P_o = 0 \text{ dB}$
ISO					
Com-Ref@ λ_1		18		dB	
Ref-Pass@ $\lambda_2/\lambda_3/\lambda_4/\lambda_5/\lambda_6/\lambda_7$		30		dB	
Polarization Dependent Loss					
Directivity	D	50		dB	
Return Loss	RL	45		dB	$\lambda = \lambda_1 (P_o = 0 \text{ dBm})$
Insertion Loss					
Pass Channel	IL		0.8	dB	$\lambda = \lambda_1$ (test with connector)
Reflect Channel	IL		0.7	dB	$\lambda = \lambda_2/\lambda_3/\lambda_4/\lambda_5/\lambda_6/\lambda_7$ (test with connector)

4.4 PD Pin Assignment

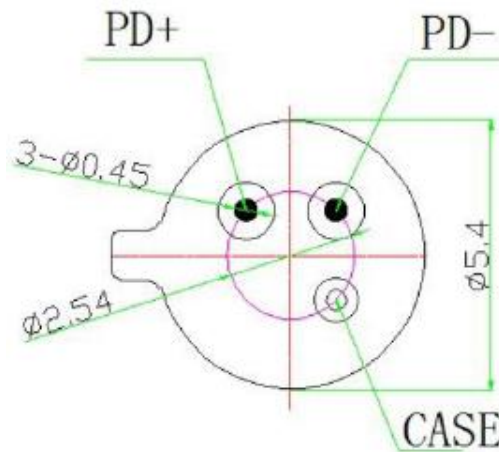

Bottom view

4.5 Mechanical Dimensions

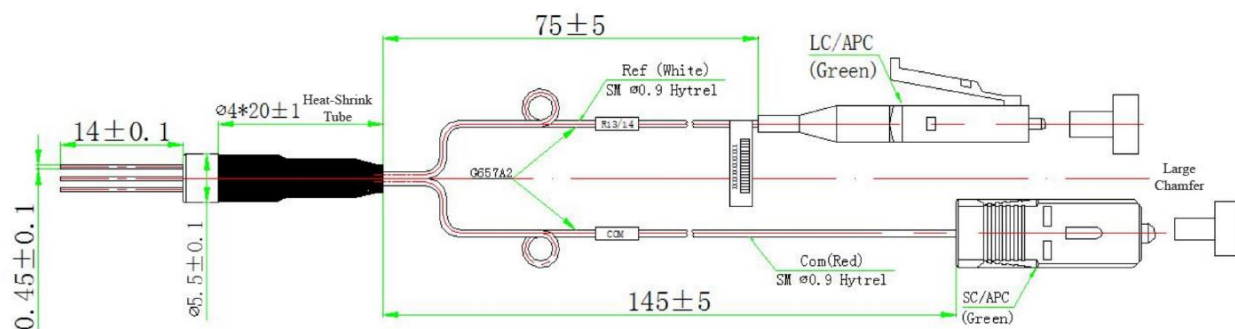

5 Troubleshooting

POWER LED off

Ensure that the unit is connected to a suitable power source. The power adapter for this equipment has an input of 220 V and an output of 12 V DC. If the STATUS LED is still off, the unit is likely to be faulty and should be returned to Ascent Communication Technology for repair.

OPT. IN LED showing red

The optical level entering the unit is too low or too high and must be adjusted externally to the unit, for optimal performance.

If the optical level entering the unit is too high, it could cause permanent damage to the unit. The signal should be disconnected and attenuated to an appropriate level, before reconnection to the AON120D. If the unit does not function as specified it is possible that the unit has been damaged and should be returned to Ascent Communication Technology for repair.

No RF output

Ensure that a forward-path signal is present on the system, at the correct wavelength for the AON120D to receive. If the signal is present, but not at the desired level, adjust the RF ATT control.

Keep the optical connector clean, a poor link will reduce the RF output level.



Ascent Communication Technology Ltd

AUSTRALIA

140 William Street, Melbourne
Victoria 3000, AUSTRALIA
Phone: +61-3-8691 2902

Hong Kong SAR

Room 1210, 12th Floor, Wing Tuck Commercial Centre
181 Wing Lok Street, Sheung Wan , Hong Kong SAR
Phone: +852-2851 4722

CHINA

Unit 1933, 600 Luban Road
200023, Shanghai, CHINA
Phone: +86-21-60232616

USA

2710 Thomes Ave
Cheyenne, WY 82001, USA
Phone: +1 203 350 9822

EUROPE

Pfarrer-Bensheimer-Strasse 7a
55129 Mainz, GERMANY
Phone: +49 (0) 6136 926 3246

VIETNAM

11th Floor, Hoa Binh Office Tower
106 Hoang Quoc Viet Street, Nghia Do Ward
Cau Giay District, Hanoi 10649, VIETNAM
Phone: +84-24-37955917

WEB: www.ascentcomtec.com

EMAIL: sales@ascentcomtec.com

Specifications and product availability are subject to change without notice.
Copyright © 2026 Ascent Communication Technology Limited. All rights reserved.
Ver. ACT_AON120D_Mini_Node_QRG_V1j_Jan_2022